

# Data Sheet



Article number: 604133038040

Description: Taper bored timing belt pulley  
HTD 38 14M 40 TL 2517

## Measures

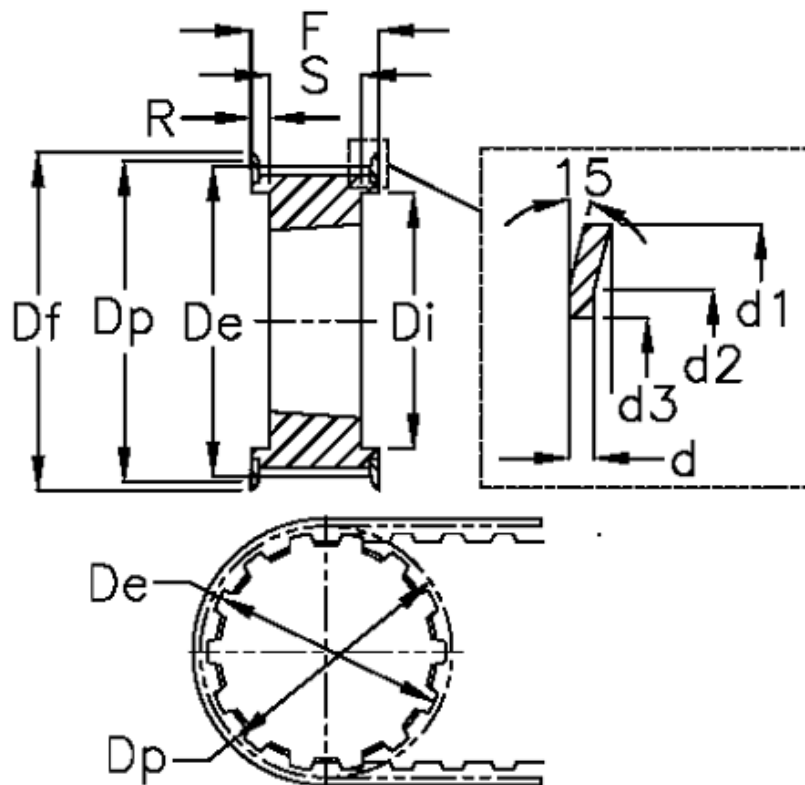

d = 2.5	F = 54	Weight = 5.4
d1 = 184	Flange type = F55	Width = 40
d2 = 168	For bushing = 2517	
d3 = 135	Max bore = 60	
De = 166.6	r = 4.5	
Df = 184	S = 45	
Di = 130	Tooth number = 38	
Dp = 169.34	Type = 14M	